

Guided Surgery Kit

Catalog & Surgical Manual

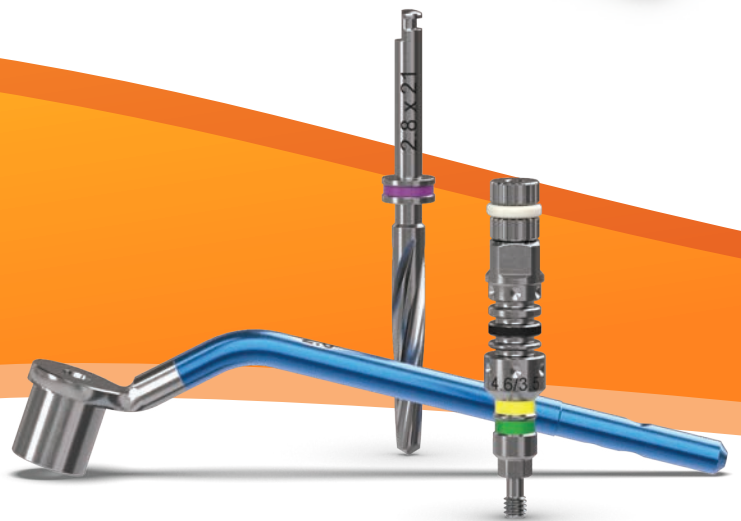



BioHorizons Tapered implants

Every implant treatment presents its own challenge. BioHorizons broad portfolio of Tapered implants provides solutions for all indications. Choose from narrow-diameter 3.0mm implants to wide-diameter immediate molar implants or short 6mm-length implants to 18mm-length implants. Whatever your preference, there's a workflow to suit your need, from fully digital to traditional.



guided workflow

BioHorizons guided surgery system uses an open architecture design, providing compatibility with various software providers and guide manufacturers.*



digital restorative workflow

Custom abutments can be sourced through validated milling centers or designed and fabricated in-house.



traditional workflow

BioHorizons comprehensive surgical kit and wide range of prosthetics support traditional workflows.

learn more at biohorizons.com

*Mount-free Tapered Pro, Tapered PTG, Tapered Internal, Tapered Plus, Tapered 3.0 and Tapered Tissue Level implants



Table of contents

Guided Surgery Kit Overview	2-3
Guided Surgery Process	4
Guided Surgery Instruments	5-7
Ancillary Instruments	8-10
Color-coding for Tapered Pro	11
Color-coding for Tapered Internal	12
Color-coding for Tapered Plus	13
Color-coding for Tapered Tissue Level	14
Color-coding for Tapered PTG	15
Instructions for Use	16
Surgery Kit & Drill Sequence	17
Guide Cylinders Overview	18
Guided Surgery Preparation	19-20
Drill Overview	21
Guided Surgery Case Example	22-25
Instructions & Icon Legend	26
Notes	27
Ordering, Warranty Information & References	28

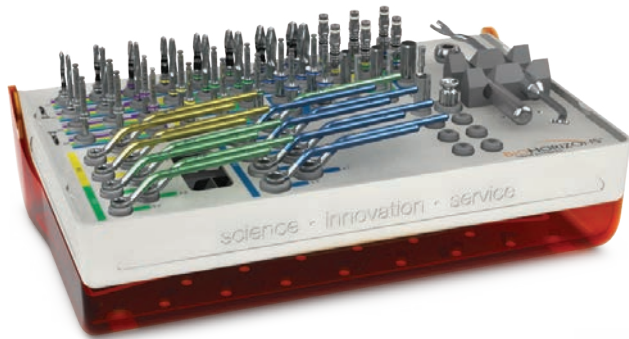

the BioHorizons guided surgery kit

The BioHorizons guided surgery kit offers the precision and predictability of guided implant placement with a streamlined, single kit design. All components are color-coded to avoid the complexity seen with other systems while offering our customers predictable implant placement for optimal esthetic outcomes.

surgical guide flexibility

Open architecture design for fabrication of surgical guides

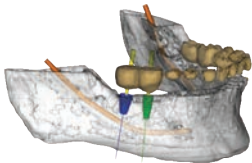

guided implant control

Implant is placed to planned depth using a surgical guide created from a virtual treatment plan

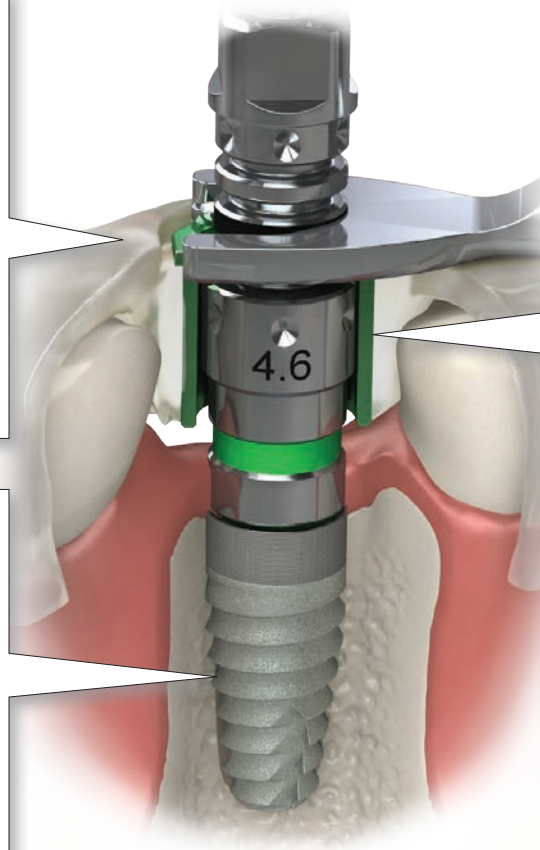
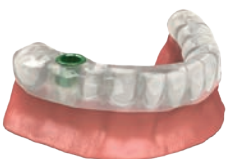

ease of use

Master cylinders and instruments are color-coded to ensure proper component usage



perfect fit for precise implant placement

The guided surgery kit can be used to place all diameters from 3.0mm to 5.8mm of the highly successful Tapered Pro, Tapered PTG, Tapered Internal, Tapered Plus, Tapered Tissue Level and Tapered 3.0 implants.*

surgical kit features:

- the surgical protocol details the instrument sequence from site preparation to implant placement
- surgical instrument design and single kit layout avoids the complexity of other surgical kits
- implant drivers seat the implants to proper depth through the master cylinder using depth stops
- precision fit and color-coding ensures accurate execution of the virtual treatment plan

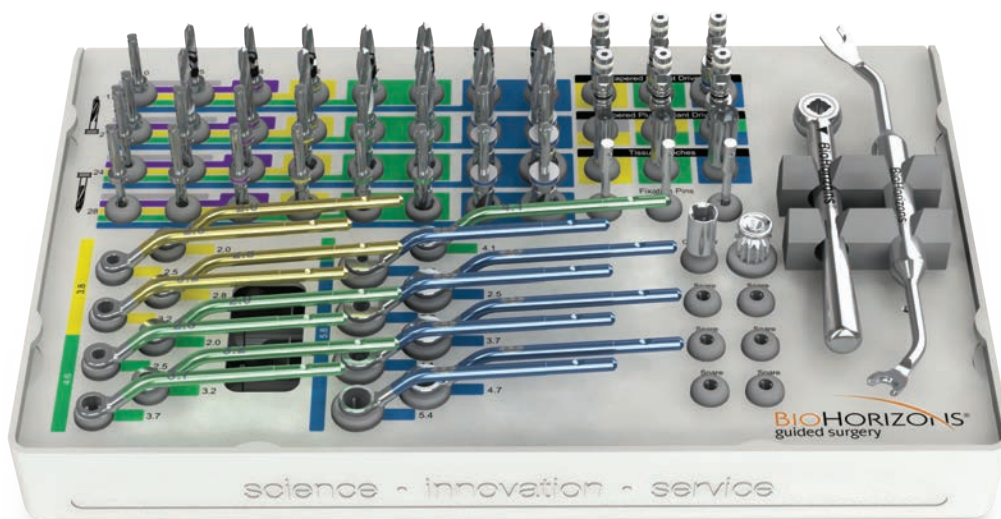

* 5.2/5.8mm instruments sold separately. TSGKIT is required for guided placement of Tapered Short implants.

Guided Surgery Process

Surgical plan to surgical guide

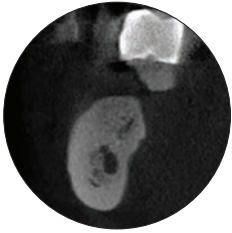

1. Clinical step - CT scan appointment

Initial patient records and CT scan. CT scan protocols will vary depending on the guide manufacturer. Guide manufacturers details are available at <https://biohorizons.com/Products/workflowpartners>.



2. Clinical step - Treatment plan

Diagnose and treatment plan for guided surgery. Determine if adequate vertical space is available to accommodate the surgical guide and related components. Import CT scan data into the treatment planning software and design the case.



3. Guide manufacturer step - Guide fabrication

Guide manufacturer fabricates the surgical guide using the virtual treatment plan, BioHorizons master cylinders and pilot sleeves. A patient-specific surgical protocol is generated for the clinician to follow.

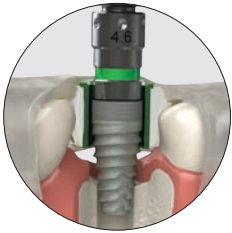

4. Clinical step - Guided surgery

Clinician performs the procedure using the surgical guide and the BioHorizons guided surgery kit while following the surgical protocol.



Guided Restorative Solutions

by Vulcan and BioHorizons

Guided Restorative Solutions (GRS) combines the efficiency and predictability of guided surgery, with hybrid or titanium custom abutments. GRS conveniently delivers everything needed for a case, including BioHorizons implants.

Learn more: www.vulcandental.com



The surgical guide must be fabricated using BioHorizons manufactured master cylinders and pilot sleeves. Please contact your guide manufacturer for further information.

Guided Surgery Instruments

Guided surgery kit

CGS4000

Guided Surgery Kit (with instruments)

Includes the instruments required to place BioHorizons Tapered Implants. 5.2mm and 5.8mm implant instruments are sold separately.

CGS3500

Guided Surgery Tray & Lid (without instruments)



features:

- versatile, removable, hinged lid
- easy to disassemble and assemble during cleaning
- spare slots for additional instrumentation
- single color-coded kit for placement of BioHorizons Tapered implants*

Individual components



CGS-YTP

3.8mm CGS Tissue Punch

CGS-GTP

4.6mm CGS Tissue Punch



CGS-FP

CGS Fixation Pin

3 included with kit



130-000

Ratchet



135-351

.050" (1.25mm) Hex Driver

* Mount-free Tapered Pro, Tapered PTG, Tapered Internal, Tapered Plus, Tapered 3.0, Tapered Tissue Level.

Guided Surgery Instruments

Drills









Guided surgery drills with definitive depth stops follow the standard Tapered implant drill sequences and come in four different lengths. The patient-specific surgical protocol that accompanies the surgical guide will indicate which drill length and widths to use.



	2.0mm pilot	2.5mm width	2.8mm width	3.2mm width	3.7mm width	4.1mm width
17mm stop	122-017	CGS-2517	CGS-2817*	CGS-3217	CGS-3717	CGS-4117
21mm stop	122-021	CGS-2521	CGS-2821*	CGS-3221	CGS-3721	CGS-4121
24mm stop	122-024	CGS-2524	CGS-2824*	CGS-3224	CGS-3724	CGS-4124
28mm stop	122-028	CGS-2528	CGS-2828*	CGS-3228	CGS-3728	CGS-4128

Drill guides

Drill guides are color-coded to match the master cylinders. Use the proper size drill guide with the corresponding drill diameter to sequentially widen the osteotomy. The text on the drill guide specifies the corresponding drill width.

	2.0mm	2.5mm	2.8mm	3.2mm	3.7mm	4.1mm
3.8mm	CGS-DGY20 	CGS-DGY25 	CGS-DGY28* 	CGS-DGY32 	-	-
4.6mm	CGS-DGG20 	CGS-DGG25 	-	CGS-DGG32 	CGS-DGG37 	CGS-DGG41 

Quick connect handles

Quick connect handles are used in combination with the drill guides. The handles can be assembled pre-operatively with the specified drill guides.

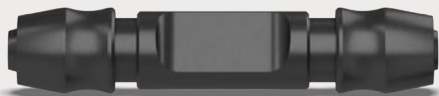

CGS-QCH

CGS Quick Connect Handle

2 included with kit

* 2.8mm instruments are only required to place the 3.4mm diameter implant.

Guided Surgery Instruments

Screw-retained implant drivers

Screw-retained implant drivers are used to pickup and seat implants when used with a 4mm square ratchet. The driver is secured to the implant using the captured screw and can be easily released after implant placement. Use the depth stops to seat the implants to the planned depth. Orient the implant hex using the dimples as a visual reference. The screw-retained drivers low profile improves access when vertical space is limited. These drivers can be used with a handpiece when using the 4mm Square Driver Converter.



Tapered Internal Implant Drivers

- CGS-PYIDR** 3.8mm CGS Screw-retained Implant Driver*
- CGS-PGIDR** 4.6mm CGS Screw-retained Implant Driver*



Tapered Plus Implant Drivers

- CGS-TP3IDR** 3.8mm CGS Screw-retained Implant Driver, 3.0mm Platform*
- CGS-PYGIDR** 4.6mm CGS Screw-retained Implant Driver, 3.5mm Platform*

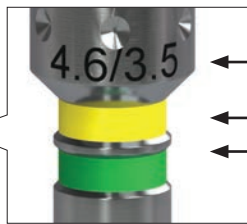

Tapered Plus Implant Driver Markings

- laser marking indicates body diameter / prosthetic platform body
- diameter top band indicates prosthetic platform
- bottom band indicates master cylinder



- CGS-4SC** 4mm Square Drive Converter
Drive converter allows the screw-retained drivers to be used with a handpiece.

Depth stops



- CGS-DH** CGS Depth Stop Handle
Engages the implant driver to place the implant at the proper depth through the master cylinder.



- CGS-DDS** CGS Disposable Depth Stop
Snaps onto the specified stop position pre-operatively for hands-free implant depth control.

* Instrument o-rings & c-rings wear out over time. If an instrument is no longer held securely by its associated driver, order a replacement ring through Customer Care.

Ancillary Instruments (sold separately)

5.2/5.8mm implant drills

The 4.7mm and 5.4mm drills allow for placement of the 5.2mm and 5.8mm diameter implants.



4.7mm width CGS drills

CGS-4717	4.7 x 17mm CGS Drill
CGS-4721	4.7 x 21mm CGS Drill
CGS-4724	4.7 x 24mm CGS Drill
CGS-4728	4.7 x 28mm CGS Drill



5.4mm width CGS drills

CGS-5417	5.4 x 17mm CGS Drill
CGS-5421	5.4 x 21mm CGS Drill
CGS-5424	5.4 x 24mm CGS Drill
CGS-5428	5.4 x 28mm CGS Drill

5.2/5.8mm implant drill guides

	2.0mm	2.5mm	3.2mm	3.7mm	4.1mm	4.7mm	5.4mm
5.8mm	CGS-DGB20	CGS-DGB25	CGS-DGB32	CGS-DGB37	CGS-DGB41	CGS-DGB47	CGS-DGB54

5.2/5.8mm implant drivers



Tapered Internal Implant Driver

CGS-PBIDR

5.8mm CGS Screw-retained Implant Driver*



Tapered Plus Implant Driver

CGS-PGBIDR

5.8mm CGS Screw-retained Implant Driver, 4.5mm Platform*

5.8mm tissue punch



CGS-BTP

5.8mm CGS Tissue Punch

* Instrument o-rings & c-rings wear out over time. If an instrument is no longer held securely by its associated driver, order a replacement ring through Customer Care.

Ancillary Instruments (sold separately)

ISO-latch implant drivers (one-piece)

ISO-Latch implant drivers can be used as a one-piece alternative to the screw-retained drivers. Use the depth stops to seat the implants to the planned depth. Orient the implant hex using the dimples as a visual reference.



Tapered Internal Implant Drivers

- CGS-PYIDH** 3.8mm CGS Implant Driver*
- CGS-PGIDH** 4.6mm CGS Implant Driver*
- CGS-PBIDH** 5.8mm CGS Implant Driver*



Tapered Plus Implant Drivers

- CGS-TP3IDH** 3.8mm CGS Implant Driver, 3.0mm Platform*
- CGS-PYGIDH** 4.6mm CGS Implant Driver, 3.5mm Platform*
- CGS-PGBIDH** 5.8mm CGS Implant Driver, 4.5mm Platform*

Tapered Plus Implant Driver Laser Marking

laser marking indicates body diameter / prosthetic platform



Tapered Plus Implant Driver Color-Coding

- top band indicates prosthetic platform
- bottom band indicates master cylinder

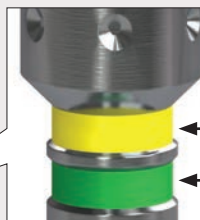

* Instrument o-rings & c-rings wear out over time. If an instrument is no longer held securely by its associated driver, order a replacement ring through Customer Care.

Ancillary Instruments (sold separately)

Driver attachments

The driver attachments allow for the screw-retained drivers to be extended or used manually.



300-205

Ratchet & Hand Wrench Extender*

300-400

Hand Wrench

Implant mount

The implant mount provides additional surgical guide fixation. The mount is designed to pass through the surgical guide and screw into an implant that has already been placed; the thumb wheel is then tightened, fixing the guide in the patients' mouth.



CGS-IM

CGS Implant Mount

.050" (1.25mm) hex drivers

For installation and removal of cover caps, prosthetic and abutment screws.

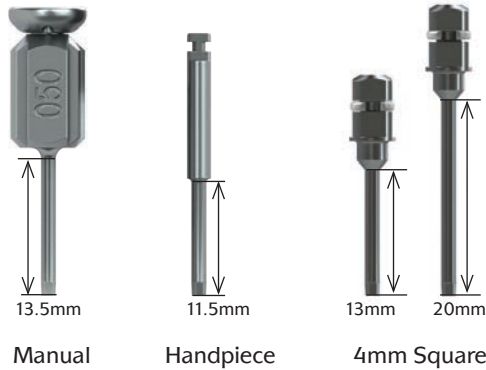

135-451

Manual Hex Driver, Long

134-450

Handpiece Hex Driver, Long

300-351

4mm Square Hex Driver, Long*

300-354

4mm Square Hex Driver, Extra Long*

Torque wrench



C12374

Elos Adjustable Torque Wrench

Lightweight titanium design is easy to use as an adjustable torque wrench. Quickly disassembles for cleaning. No calibration required.



C8521

Elos Replacement Bit, 4mm Square Driver

















C8381

Elos Replacement Bit, Handpiece Driver

* Instrument o-rings & c-rings wear out over time. If an instrument is no longer held securely by its associated driver, order a replacement ring through Customer Care.

BioHorizons Tapered Implants

Color-coding for Tapered Pro

	3.8mm	4.2mm	4.6mm	5.2mm
9.0mm length	BTA3809	BTA4209	BTA4609	BTA5209
10.5mm length	BTA3810	BTA4210	BTA4610	BTA5210
12.0mm length	BTA3812	BTA4212	BTA4612	BTA5212
15.0mm length	BTA3815	BTA4215	BTA4615	BTA5215
18.0mm length	BTA3818 [†]	BTA4218 [†]	BTA4618 [†]	-
apical diameter	2.8mm	3.0mm	3.2mm	3.3mm
Laser-Lok zone	1.8mm	1.8mm	1.8mm	1.8mm
implant body				
master cylinder				
drill guides				
prosthetic connection	 3.0mm	 3.5mm	 3.5mm	 4.5mm
implant driver				



Tapered Pro

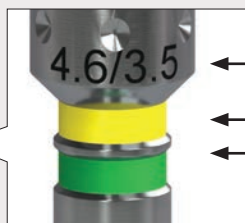

Tapered Plus Implant Driver Markings











- ← laser marking indicates body diameter / prosthetic platform body
- ← diameter top band indicates prosthetic platform
- ← bottom band indicates master cylinder

[†] When placing 18mm length implants using the guided surgery kit, the drills will progress 0.54mm deeper than the final implant placement/depth.

BioHorizons Tapered Implants

Color-coding for Tapered Internal

BioHorizons implants can be delivered through the surgical guide. If attempting to use BioHorizons mounted implants, the 3inOne® abutment will have to be removed prior to implant delivery.

	3.0mm	3.4mm	3.8mm	4.6mm	5.8mm
7.5mm length	—	—	—	TLX4607	TLX5807
9.0mm length	—	TLX3409	TLX3809	TLX4609	TLX5809
10.5mm length	TLX3010	TLX3410	TLX3810	TLX4610	TLX5810
12.0mm length	TLX3012	TLX3412	TLX3812	TLX4612	TLX5812
15.0mm length	TLX3015	TLX3415	TLX3815	TLX4615	TLX5815
18.0mm length	-	TLX3418 [†]	TLX3818 [†]	TLX4618 [†]	-
apical diameter	2.0mm	2.4mm	2.8mm	3.1mm	3.9mm
Laser-Lok zone	2.1mm	1.8mm	1.8mm	1.8mm	1.8mm
implant body					
master cylinder					
drill guides					
prosthetic connection	 3.0mm	 3.0mm	 3.5mm	 4.5mm	 5.7mm
implant driver					
	3.8/3.0 Tapered Plus Implant Driver		Tapered Internal Implant Driver		



Tapered 3.0 & Tapered Internal







The 3.0 and 3.4mm implants use the 3.8mm master cylinder and drill guides. The guided implant placement of the 3.0 and 3.4mm implants will be properly controlled by using the 3.8/3.0 Tapered Plus implant driver.

[†] When placing 18mm length implants using the guided surgery kit, the drills will progress 0.54mm deeper than the final implant placement/depth.

BioHorizons Tapered Implants

Color-coding for Tapered Plus

	3.8mm	4.6mm	5.8mm
7.5mm length	—	TLXP4607	TLXP5807
9.0mm length	TLXP3809	TLXP4609	TLXP5809
10.5mm length	TLXP3810	TLXP4610	TLXP5810
12.0mm length	TLXP3812	TLXP4612	TLXP5812
15.0mm length	TLXP3815	TLXP4615	TLXP5815
apical diameter	2.8mm	3.1mm	3.9mm
platform switch	0.4mm	0.5mm	0.6mm
Laser-Lok zone	1.8mm	1.8mm	1.8mm
implant body			
master cylinder			
drill guides			
prosthetic connection	 3.0mm	 3.5mm	 4.5mm
implant driver			





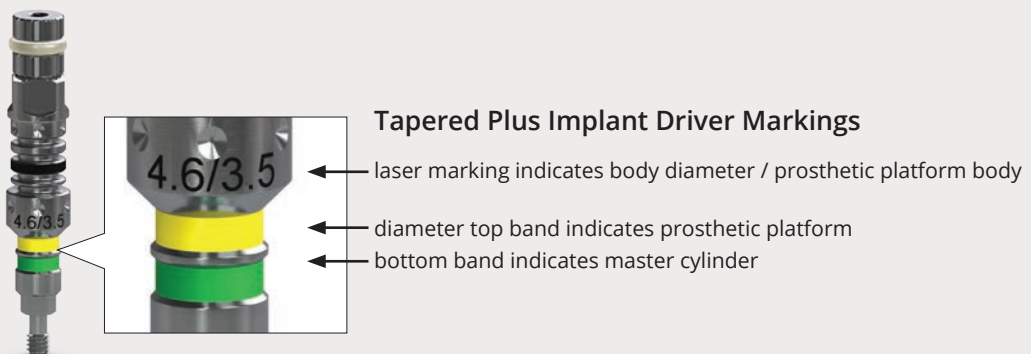





Tapered Plus



BioHorizons Tapered Implants

Color-coding for Tapered Tissue Level

	3.0mm	3.8mm	4.6mm	5.8mm
7.5mm length	—	TTLY3807	TTLG4607	TTLB5807
9.0mm length	—	TTLY3809	TTLG4609	TTLB5809
10.5mm length	TTLY3010	TTLY3810	TTLG4610	TTLB5810
12.0mm length	TTLY3012	TTLY3812	TTLG4612	TTLB5812
apical diameter	2.0mm	2.8mm	3.1mm	3.9mm
Laser-Lok zone	2.0mm	2.0mm	2.0mm	2.0mm
implant body				
master cylinder (for osteotomy only)				
drill guides				
prosthetic connection	 3.5mm	 3.5mm	 4.5mm	 5.7mm
implant driver (for placing implant without the guide)				



Tapered Tissue Level

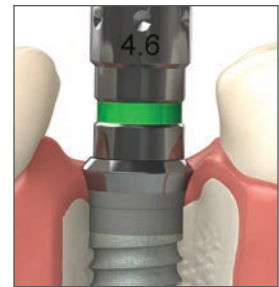





Remove the guide to ensure the soft tissue collar is placed at the correct depth



Removal of the guide is necessary before placing Tapered Tissue Level implants, as the soft tissue collar will not fit through the master cylinder. The guided surgery protocol enables the osteotomy to be created to the correct depth, angulation and diameter.

BioHorizons Tapered Implants

Color-coding for Tapered PTG

	4.2mm
15.0mm length	PTG4215
18.0mm length	PTG4218†
apical diameter	2.2mm
Laser-Lok zone	1.8mm
implant body	
master cylinder	
drill guides	
prosthetic connection	 3.5mm
implant driver	



Tapered PTG

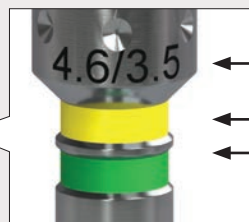

Tapered Plus Implant Driver Markings

- ← laser marking indicates body diameter / prosthetic platform body
- ← diameter top band indicates prosthetic platform
- ← bottom band indicates master cylinder

† When placing 18mm length implants using the guided surgery kit, the drills will progress 0.54mm deeper than the final implant placement/depth.

Surgical Manual

Instructions for use



This surgical manual serves as a reference for using the Guided Surgery Kit. It is intended solely to provide instructions on the use of BioHorizons products. It is not intended to describe the methods or procedures for diagnosis, treatment planning, or placement of implants, nor does it replace clinical training or a clinician's best judgment regarding the needs of each patient. BioHorizons strongly recommends appropriate training as a prerequisite for the placement of implants and associated treatment.

The procedures illustrated and described within this manual reflect idealized patient presentations with adequate bone and soft tissue to accommodate implant placement. No attempt has been made to cover the wide range of actual patient conditions that may adversely affect surgical and prosthetic outcomes. Clinician judgment as related to any specific case must always supersede any recommendations made in this or any BioHorizons literature.

Before beginning any implant surgical procedure using the BioHorizons Guided Surgery Kit:



- Read and understand the Instructions for Use that accompany the products.
- Clean and sterilize the surgical tray and instruments following the Instructions for Use.
- Become thoroughly familiar with all the instruments and their uses.
- Study the surgical kit layout and iconography.
- Design a surgical treatment plan to satisfy the prosthetic requirements of the case.

Indications

The Guided Surgery Kit is intended to facilitate the creation of an osteotomy for placement of BioHorizons implants using a surgical guide that incorporates BioHorizons manufactured master cylinders. The bone cutting instruments are intended for use in the mandible or maxilla for partially and fully edentulous arches.

Surgery Kit & Drill Sequence

Guided surgery kit instructions

Prior to use, clean and sterilize the surgical tray and instruments according to the Instructions for Use included with the kit. Study the kit layout, color-coding and iconography. Surgical assistants should be thoroughly familiar with all instruments and their uses prior to initiating the surgical procedure.

The drill section includes drills with definitive stops at lengths of 17, 21, 24, and 28mm. Drills of 17mm and 21mm in length should be stored with the flutes up while the 24mm and 28mm drills should be stored with the flutes down.

The implant driver section includes drivers for BioHorizons Tapered implants.

The drill guide section includes the drill guides to be used with the drills for implant site preparation.

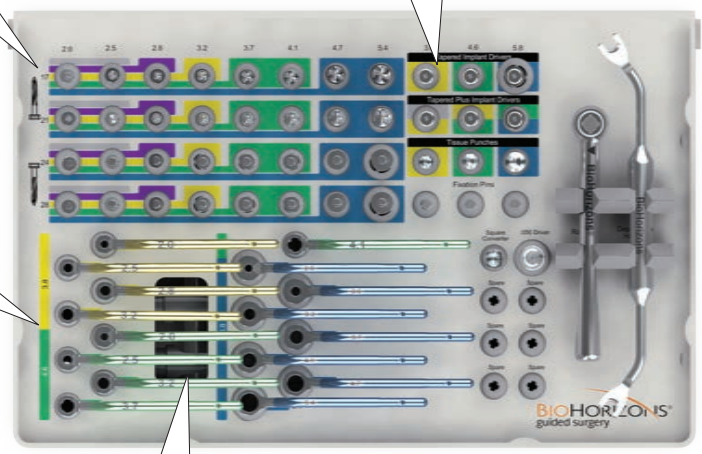

Quick connect handles are located under the tray insert.

CGS drill sequence

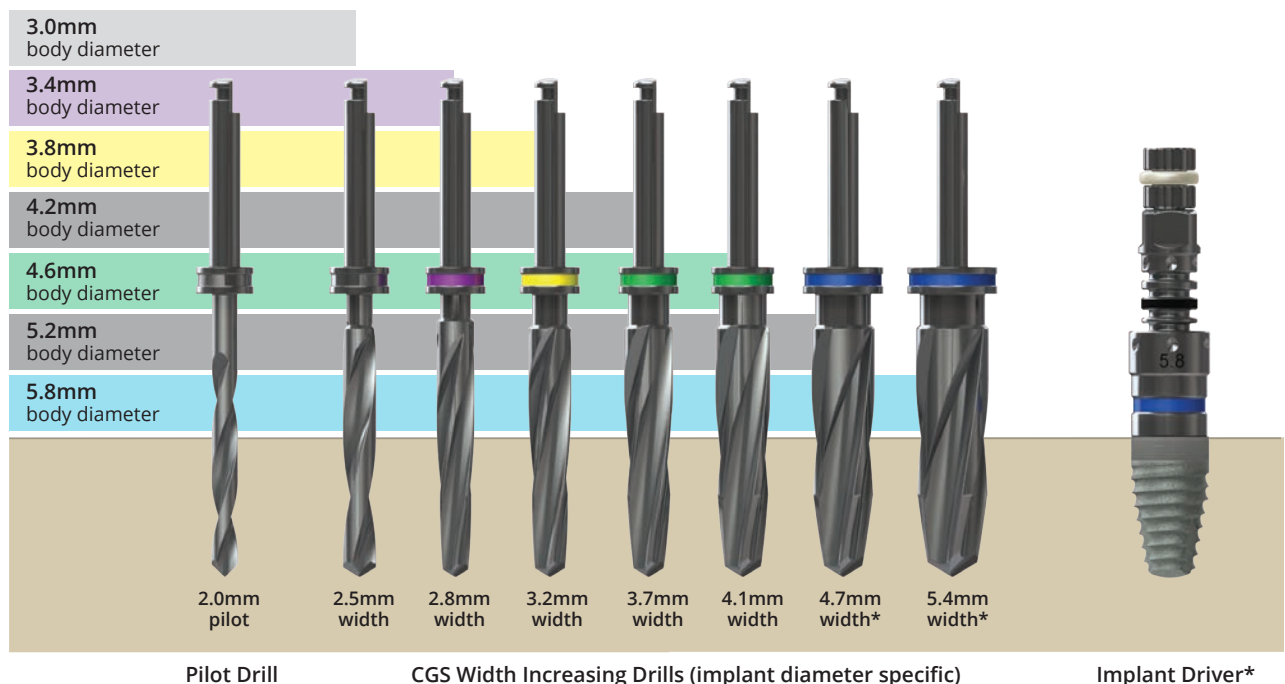

* 5.2/5.8mm instruments sold separately.

Guide Cylinders Overview

Master cylinders and pilot sleeves

Patient anatomy and the virtual treatment plan determine the master cylinder and/or pilot sleeve to be used in the surgical guide. Three different master cylinder diameters and two pilot sleeves are available.



		height	drill guide requirement	implant body diameter
	CGS-YMC-10	6mm	yes	3.0mm, 3.4mm & 3.8mm
	CGS-GMC-10	6mm	yes	4.6mm
	CGS-BMC-10	6mm	yes	5.8mm
	CGS-PS4-10	4mm	no	n/a
	CGS-PS6-10	6mm	no	n/a

Pilot sleeves can be used when interdental space is limited due to patient anatomy or if a collision between the master cylinders is anticipated.

Master Cylinder Collision



Master Cylinder Collision Correction



Guided Surgery Preparation

Pre-surgery preparation

Inspect the surgical guide for defects and potential weak areas. Visually evaluate the position of the master cylinder and/or pilot sleeve to ensure it is placed according to the treatment plan.

Ensure the thru hole of the drill guides, pilot sleeves, and master cylinders are free of debris.

The surgical guide must have a stable fit to the patient's anatomy. If a stable fit cannot be obtained at time of surgery, the surgical guide should not be used. Do not use excessive force to seat the surgical guide.

Review the surgical plan and instruments within the kit prior to surgery. Drill use should be cross-checked against the drill usage chart (ML0226). Any drills that are worn, marked or dull should be replaced. Be conscious of the specified implant driver stop position (SP1 – SP4) if indicated.

Place the drill in the handpiece and check the fit with all the drill guides and pilot sleeves prior to surgery.



Quick connect handle

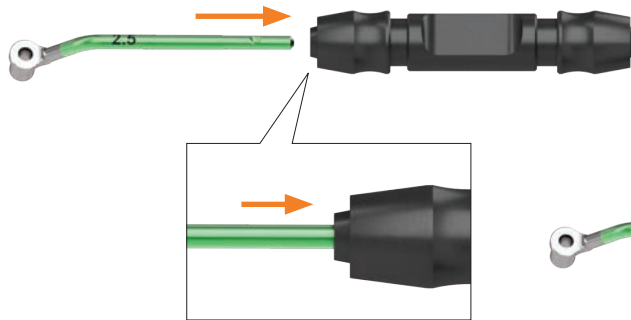

Assemble the quick connect handle. Insert the drill guide into the quick connect handle while depressing the end portion.



Firmly hold the quick connect handle or drill guide while progressing through the drill sequence.

Guided Surgery Preparation

Drilling technique

Fully seat the drill guide into the master cylinder. Ensure the drill has a resistance free path of insertion by pumping the drill in-and-out of the drill guide prior to drilling.

- In cases where the patient has limited opening/interocclusal space, components may be stacked out of the mouth. Insert the drill in the handpiece and place through the appropriate drill guide. Then insert the assembly into the master cylinder, sliding the drill guide down into place (Figure 1). Ensure that the drill guide is evenly seated before initiating drilling (Figure 2).

Each drill should be advanced as far as possible through the drill guides and pilot sleeves prior to initiating drilling.

Use short, light strokes to progressively advance the drills to depth with minimal pressure on the drills. Profuse irrigation throughout the drilling sequence is necessary to provide lubrication and prevent overheating.

Use an in-and-out pumping action (Figure 3) to help clear flutes and drill guides of any bone debris. Drills should not be completely removed from drill guides or pilot sleeves during pumping. When finally removing drills from master cylinders and drill guides, the drill should not be rotating.



Avoid applying lateral pressure to the drill guides or pilot sleeves by ensuring the drill path is in line with the drill guide (Figures 3 & 4).

Suction and irrigation should be used between drills to remove debris from the instruments, master cylinders and the osteotomy.

Warning: Failure to follow these steps can cause the drills to bind in the drill guides.

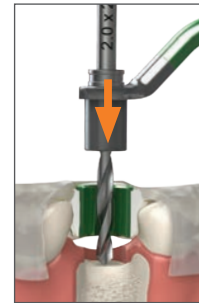

Figure 1

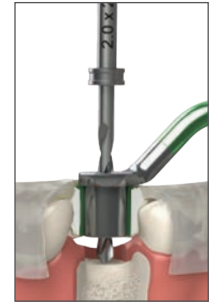

Figure 2

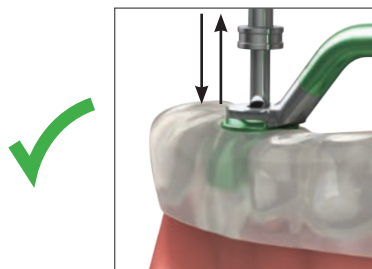

Figure 3

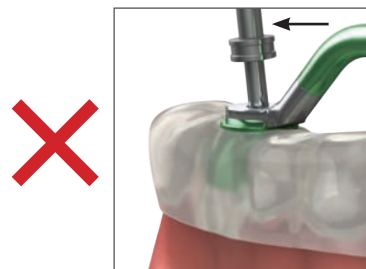

Figure 4

Pilot guide technique



Surgical guide with pilot sleeve

When using a pilot sleeve, advance the 2.0mm pilot drill without a drill guide. Once the initial osteotomy has been drilled, remove the surgical guide and proceed with the manufacturer's standard protocol for implant placement.

Drill Overview

Drill depth stops

The drills include lengths of 17, 21, 24, and 28mm and the standard diameters for all BioHorizons Tapered implants. All drills included with this system are externally irrigated and require an intermittent drilling technique with steady sterile irrigation.

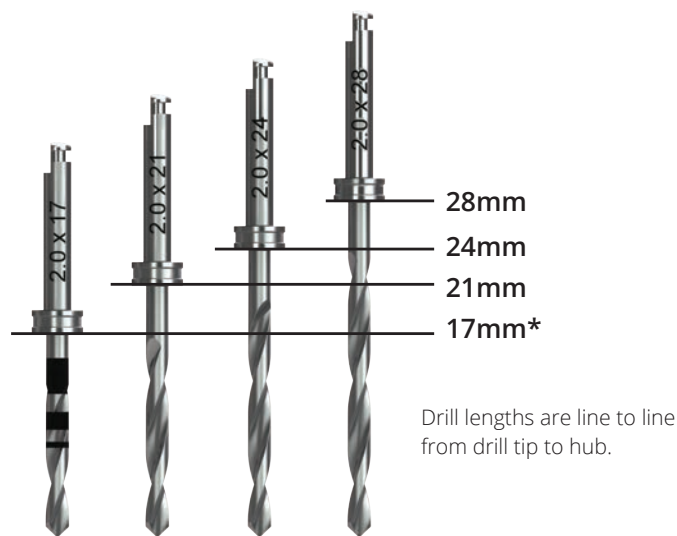

** only 17mm drills have depth markings, should they need to be used without the guide.*

Important considerations

- Peri-operative oral rinses with a 0.12% Chlorhexidine Digluconate solution have been shown to significantly lower the incidence of post-implantation infectious complications.¹ A pre-operative 30-second rinse is recommended, followed by twice daily rinses for two weeks following surgery.
- Drilling must be done under a constant stream of sterile irrigation. A pumping motion should be employed to prevent overheating the bone. Surgical drills should be replaced when they are worn, dull, corroded or in any way compromised. BioHorizons recommends replacing drills after 12 to 20 osteotomies.² A Drill-usage Tracking Chart is available at biohorizons.com to record this important information.
- There is a risk of injury to the mandibular nerve associated with surgical drilling in posterior mandibular regions. To minimize the risk of nerve injury, it is imperative that the clinician understands the virtual treatment plan created and ensures the surgical guide corresponds to the clinician's virtual treatment plan.

Guided Surgery Case Example

Placing a 4.6mm x 10.5mm Tapered Internal Implant

A patient-specific surgical protocol is included with the surgical guide. The surgical protocol includes the recommended components to be used for each implant site. Verify the protocol corresponds to the submitted virtual treatment plan prior to surgery.

Clinician judgment must always supersede any recommendations in the surgical protocol and any BioHorizons Instructions for Use.

BIOHORIZONS
SCIENCE • INNOVATION • SERVICE

Sample Protocol for BioHorizons Guided Surgery Kit	
implant label	29
implant type	TLX4610
implant length	10.5
guide site	Complete
implant site preparation	
drill length	21
drill guide/drill	2.0
drill guide/drill	2.5
drill guide/drill	3.2
drill guide/drill	3.7
drill guide/drill	4.1
drill guide/drill	
drill guide/drill	
guided implant placement	
depth position	SP2
implant driver	 4.6

Clinician judgment, as related to individual patient presentations, must always supersede recommendations in any BioHorizons Instructions for Use (IFU). Additional technical information is available upon request from BioHorizons, or may be viewed and/or downloaded at www.biohorizons.com.

2300 Riverchase Center • Birmingham, Alabama 35244 • corporate: 866.872.9785 or 205.967.7880 • fax: 205.870.0304
BioHorizons products are available in 90 countries throughout the world • www.biohorizons.com

Master cylinder position reference

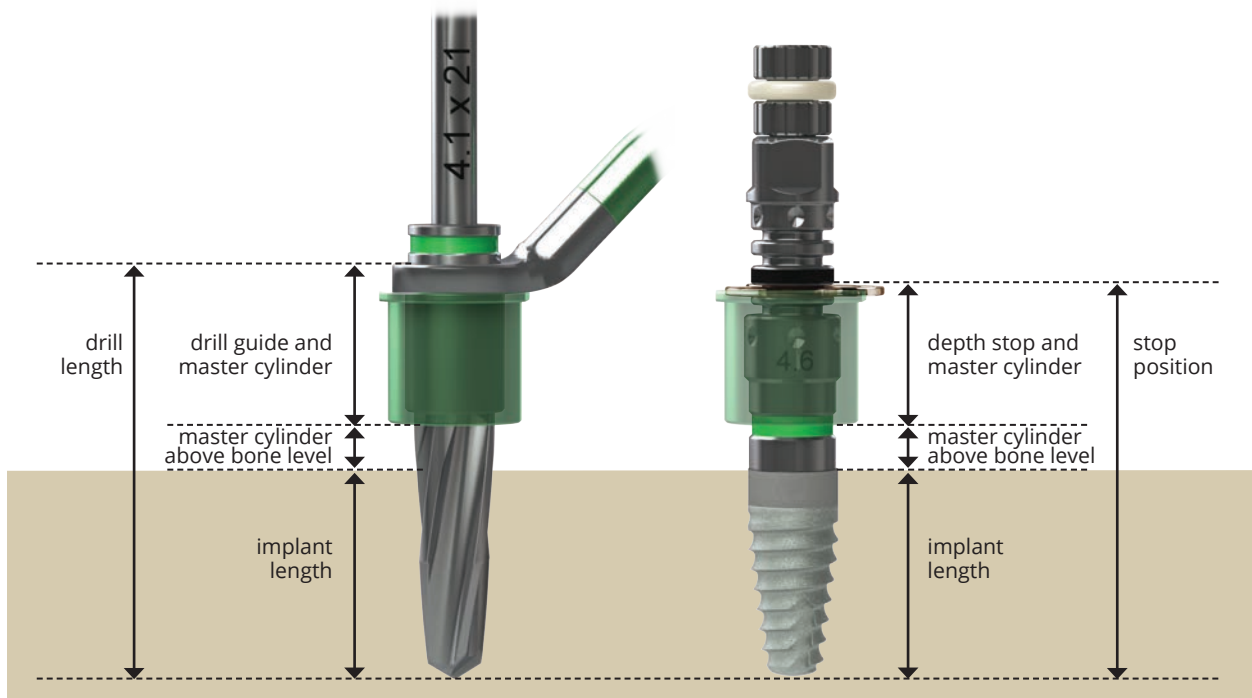

Guided Surgery Case Example

Implant site preparation

2.0 Pilot Drill and Drill Guide

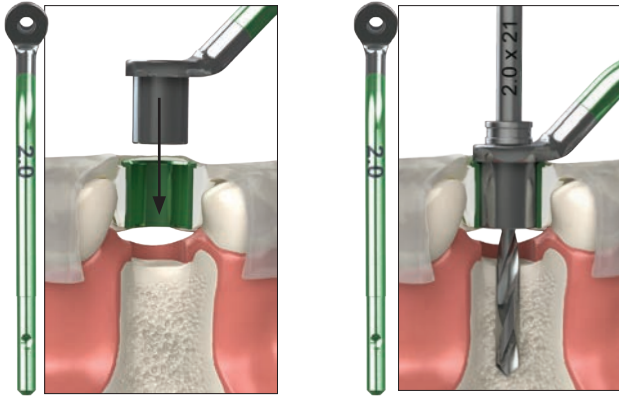

Initiate osteotomy with pilot drill

- Select the 2.0 x 21mm drill
- Place the 2.0mm drill guide in the 4.6mm master cylinder
- Insert the drill in the drill guide and use short, light strokes to progressively advance the drills until the depth stop rests on the drill guide
- Remove the 2.0mm drill guide

Width Increasing Drills and Drill Guides

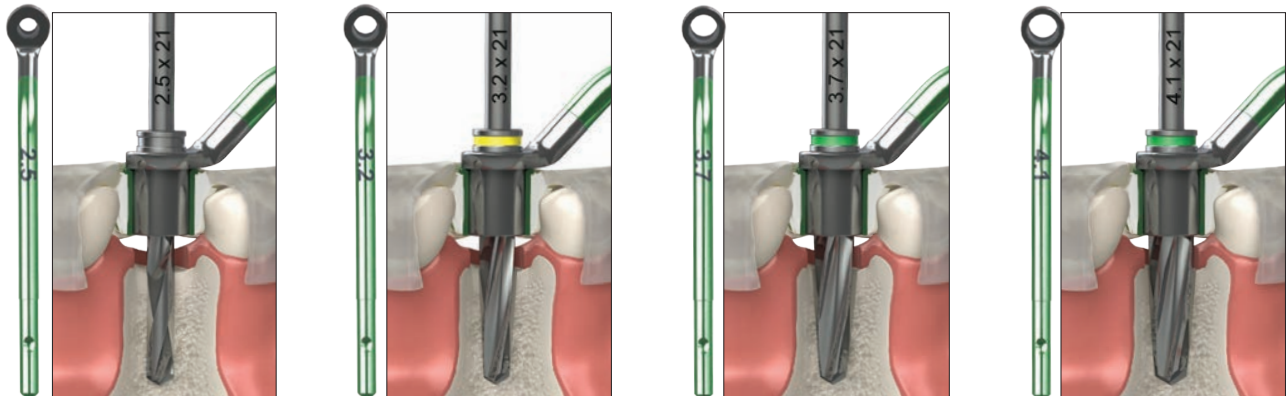

Incrementally widen the osteotomy

- Continue through the drill sequence using the specified drills and drill guides

Guided Surgery Case Example

Mount-free transfer

Vial caps are a surgical reference and are color-coded to indicate body diameter (3.0mm=white, 3.4mm=purple, 3.8mm=yellow, 4.6mm=green, 5.8mm=blue). Implant drivers are color-coded by prosthetic platform (3.0mm=gray, 3.5mm=yellow, 4.5mm=green, 5.7mm=blue) for proper mating with the implant connection.



Engage the implant with screw-retained driver by inserting the driver into the implant platform and tightening the screw. The driver can then be picked up with a handpiece by using the converter (CGS-4SC) or manually using a ratchet.



The cover cap for a two-stage surgical protocol is mounted in the vial cap.

Depth stop positions

Implant drivers include four stop positions for the depth stops to engage. Reference the patient-specific surgical protocol for the required stop position. Visual depth control can be used as an alternative to using the depth stops.

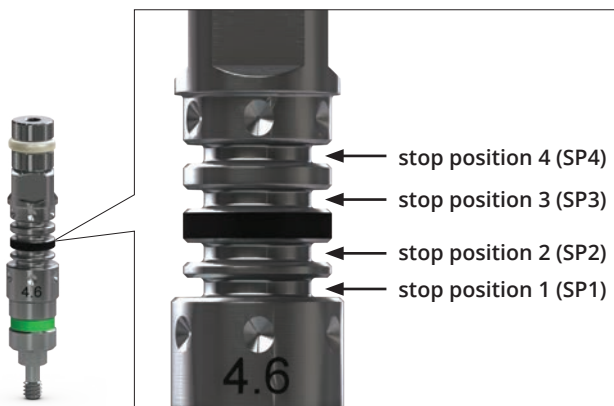

The laser-marked band above SP2 is used as a visual indicator to assist in delineating the four stop positions.

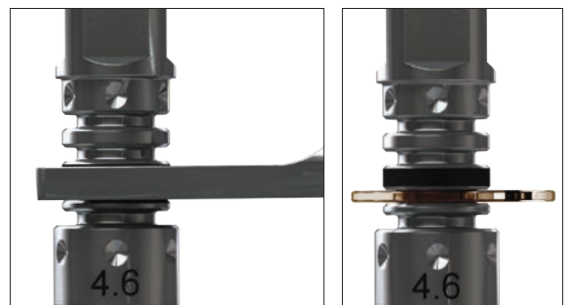

The depth stop handle or disposable depth stops can be used for guided implant depth control.



Disposable depth stops are for single use only.

Guided Surgery Case Example

Guided implant delivery

A handpiece or ratchet can be used to place the implant through the master cylinder. If a pilot sleeve is being used, the surgical guide should be removed to deliver the implant using the conventional implant placement protocol.

Implant Placement

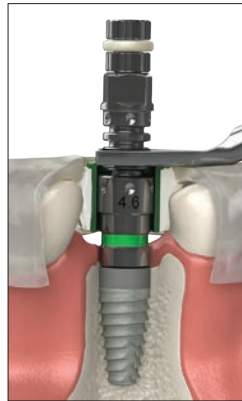
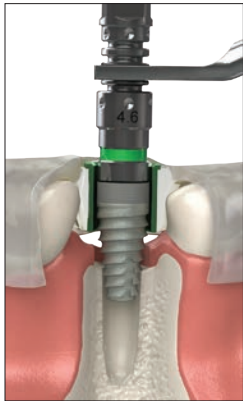

Place the implant through the master cylinder

- Using the depth stop, engage the implant driver at the SP2 position
- Ensure the shaft of the implant driver is properly aligned with the master cylinder
- Place the 4.6 x 10.5mm implant through the master cylinder



depth stop handle

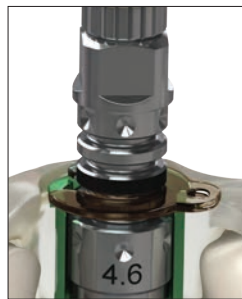

disposable depth stop

Implant depth control

- Depth placement of the implant is controlled by the depth stop engaging the indicated stop position
- The depth stop handle or disposable depth stop should firmly rest on top of the master cylinder

Screw-retained driver hex orientation

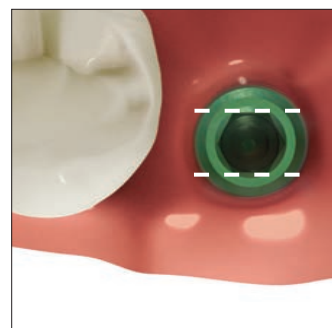
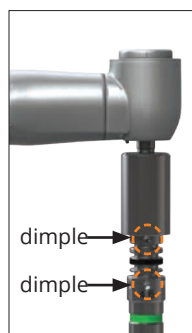
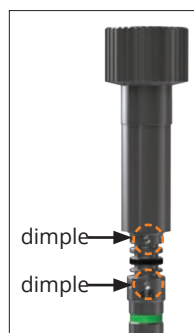
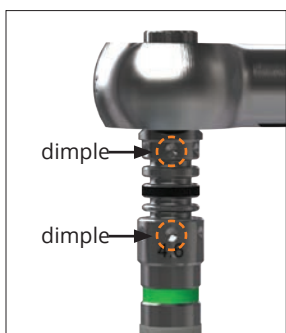

Orient the hex when using a ratchet, hand wrench or handpiece

When seating the implant with a ratchet, use the corresponding dimples on the driver to orient one internal hex flat perpendicular to the implant angulation plane.

Instructions & Icon Legend

Post-operative instructions

A period of unloaded healing time is often recommended to allow for integration between the bone and implant surface. This is dependent on individual patient healing rates and bone quality of the implant site. Each case must be independently evaluated. See the implant Instructions for Use for more information.

The patient should be instructed to follow a post-surgical regimen including cold packs for 24 hours post-implantation. The patient's diet should consist of soft foods and possibly dietary supplements. Pharmacological therapy should be considered as the patient's condition dictates.

If a removable prosthesis is used during the initial healing phase, a soft liner material should be used to prevent pressure on the surgical site. Relieve the prosthesis over the implant site prior to the soft liner application. Periodically check the patient's soft tissue and bone healing using clinical and radiographic evaluations.

Ongoing hygiene for the implant patient is vital. Hygiene recall appointments at three month intervals are suggested. Instruments designed for implant abutment scaling, such as Implacare® instruments from Hu-Friedy® should be utilized. The stainless steel handles may be fitted with assorted tip designs for hygiene on natural teeth. The Implacare® scalers contain no glass or graphite fillers that can scratch implant abutments.

Symbol descriptions for product labeling

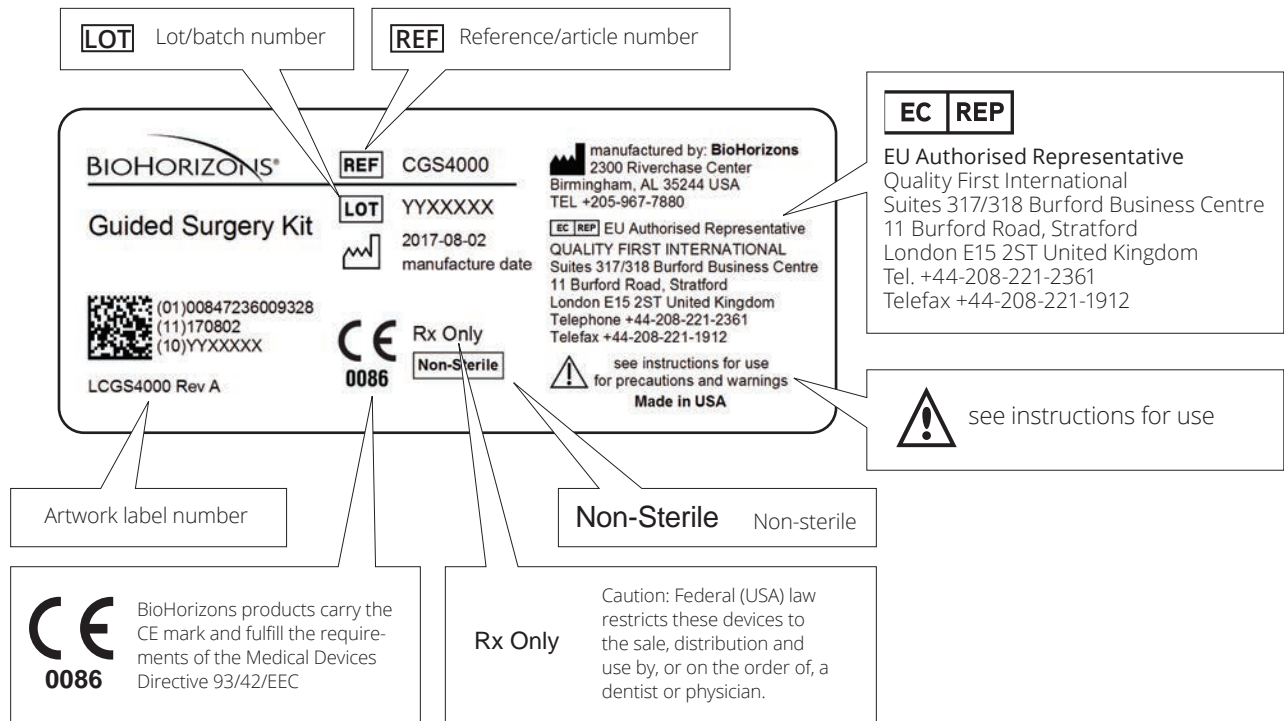

Ordering, Warranty, Information & References

Territory Manager: _____

cell phone: _____

email and/or fax: _____

BioHorizons Lifetime Warranty on Implants and Prosthetics for Clinicians: All BioHorizons implants and prosthetic components include a Lifetime Warranty. BioHorizons implant or prosthetic components will be replaced if removal of that product is due to failure (excluding normal wear to overdenture attachments).

Additional Warranties: BioHorizons warranties surgical drills, taps and other surgical and restorative instruments.

(1) Surgical Drills and Taps: Surgical drills and taps include a warranty period of ninety (90) days from the date of initial invoice. Surgical instruments should be replaced when they become worn, dull, corroded or in any way compromised. Surgical drills should be replaced after 12 to 20 osteotomies.²

(2) Instruments: The BioHorizons manufactured instrument warranty extends for a period of one (1) year from the date of initial invoice. Instruments include drivers, implant site dilators and BioHorizons tools used in the placement or restoration of BioHorizons implants.

Return Policy: Product returns require a Return Authorization Form, which may be acquired by contacting Customer Care. The completed Return Authorization Form must be included with the returned product. For more information, please see the reverse side of the invoice that was shipped with the product.

Disclaimer of Liability: BioHorizons products may only be used in conjunction with the associated original components and instruments according to the Instructions for Use (IFU). Use of any non-BioHorizons products in conjunction with BioHorizons products will void any warranty or any other obligation, expressed or implied.

Treatment planning and clinical application of BioHorizons products are the responsibility of each individual clinician. BioHorizons strongly recommends completion of postgraduate dental implant education and adherence to the IFU that accompany each product. BioHorizons is not responsible for incidental or consequential damages or liability relating to use of our products alone or in combination with other products other than replacement or repair under our warranties.

Distributed Products: For information on the manufacturer's warranty of distributed products, please refer to their product packaging. Distributed products are subject to price change without notice.

Validity: Upon its release, this literature supersedes all previously published versions.

Availability: Not all products shown or described in this literature are available in all countries. BioHorizons continually strives to improve its products and therefore reserves the right to improve, modify, change specifications or discontinue products at any time.

Any images depicted in this literature are not to scale, nor are all products depicted. Product descriptions have been modified for presentation purposes. For complete product descriptions and additional information, visit store.biohorizons.com.

References

1. The influence of 0.12 percent chlorhexidine digluconate rinses on the incidence of infectious complications and implant success. Lambert PM, Morris HF, Ochi S. *J Oral Maxillofac Surg* 1997;55(12 supplement 5):25-30.
2. Heat production by 3 implant drill systems after repeated drilling and sterilization. Chacon GE, Bower DL, Larsen PE, McGlumphy EA, Beck FM. *J Oral Maxillofac Surg*. 2006 Feb;64(2):265-9.

Direct Offices

BioHorizons USA
888-246-8338 or 205-967-7880

BioHorizons Canada
866-468-8338

BioHorizons Spain
+34 91 713 10 84

BioHorizons UK
+44 (0)1344 752560

BioHorizons Chile
+56 (2) 23619519

BioHorizons Italy
800-063-040

BioHorizons Mexico
800-953-0498

Distributors

For contact information in our 90 countries, visit biohorizons.com



shop online at
store.biohorizons.com

BioHorizons®, Laser-Lok®, MinerOss®, AutoTac®, Mem-Lok® and TeethXpress® are registered trademarks of BioHorizons. Unigrip™ is a trademark of Nobel Biocare AB. Zimmer® Dental ScrewVent® and Tapered ScrewVent® are registered trademarks of Zimmer, Inc. AlloDerm™, AlloDerm GBR™ and NovoMatrix™ are trademarks of LifeCell Corporation, an Allergan affiliate. Grafton® DBM is a registered trademark of Medtronic, Inc. Cytoplast® is a registered trademark of Osteogenics Biomedical, Inc. Puros Dermis is a registered trademark of Zimmer Biomet. Mucograft is a registered trademark of Ed. Geistlich Sogne Ag Fur Chemische Industrie. Symbios PerioDerm is a registered trademark of Dentsply Sirona. Hu-Friedy® is a registered trademark of Hu-Friedy Mfg. Co., LLC. Spiralock® is a registered trademark of Spiralock Corporation. Pomalux® is a registered trademark of Westlake Plastics Co. Locator® is a registered trademark of Zest Anchors, Inc. Delrin® is a registered trademark of E.I. du Pont de Nemours and Company. Bio-Gide® is a registered trademark of Edward Geistlich Sohne AG Fur Chemische Industrie. BioMend® is a registered trademark of Zimmer Biomet Dental. IntraSpin®, L-PRF® and Xpression® are trademarks of Intra-Lock® International Inc. Not all products shown or described in this literature are available in all countries. We are proud to be registered to ISO 13485:2016, the international quality management system standard for medical devices, which supports and maintains our product licences with Health Canada and in other markets around the globe. Original language is English. ©BioHorizons. All Rights Reserved.



L02028



REV D JUN 2021